

Hytera HyTalk



Hytera PNC380S

Push-to-Talk Over Cellular (PoC) Device

- Nationwide coverage with 4G/LTE and Wi-Fi networks
- AT&T and T-Mobile Network Approved Device
- Industry leading voice quality with digital noise suppression
- Supports dispatching, group calling, and location tracking
- Instant group voice, video, and text communications
- Easy-to-use, compact and rugged device
- Car Kit option for mounting in vehicles

Nationwide Group Communications Solution







The PNC380S is supported on the Hytera HyTalk Nationwide PoC subscription based service, on the Hytera HyTalk OnSite customer owned PoC system, and Hytera HyTalk Connect unified PoC and LMR platform. The PNC380S is also supported on Hytera HyTalk Dispatch, a powerful web-based group communications and location tracking application.

The Hytera PNC380S PoC device is a compact, rugged, and easy-to-operate handheld radio that utilizes Wi-Fi and existing nationwide 4G/LTE cellular networks for unlimited coverage and capacity. The PNC380S is designed for reliable business communications with instant group calling in the vehicle and on the job site. It is built based on an AT&T Certified LTE Module and has T-Mobile IoT Network Certification. The PNC380S can be quickly deployed without the significant infrastructure costs of traditional radio systems.



PNC380S Key Features

- 
CERTIFIED NATIONWIDE COVERAGE
 - PTCRB Certified
 - AT&T and T-Mobile approved device fully tested by for reliable nationwide connectivity
- 
INSTANT GROUP AND INDIVIDUAL CALLING
 - The PNC380s Push-to-Talk button initiates instant half-duplex group calling or full duplex individual calling
 - Supports instant group calling from the HyTalk Dispatch web-based communications and location tracking application
- 
INDUSTRY LEADING AUDIO QUALITY
 - Digital noise suppression and high-volume speakers for excellent voice quality in loud environments
 - Provides high-quality digital audio performance for individual calls, group calls, and emergency calls
- 
HIGH-DEFINITION CAMERA
 - Equipped with a rear-facing 8 megapixel rear camera, the PNC380S enables user-initiated video calls and sending high-resolution pictures
 - Video and image communications improves situational awareness, and facilitates problem solving and decision making
- 
BUILT-IN WLAN
 - Built-in Wi-Fi supports in-building communications with seamless switching to LTE networks when outside Wi-Fi range
- 
GPS POSITIONING
 - Built-in GPS enables real-time tracking and positioning for the Hytera HyTalk Dispatch application
- 
ERGONOMIC DESIGN
 - Compact and ergonomic design with easy-access buttons enables comfortable one-hand operation
 - Reversible belt clip for carrying with screen facing in or out

- 
TFT LCD DISPLAY
 - TFT LCD display provides high-resolution visibility even in bright daylight
 - Supports an easy-to-use GUI menu system with clean and simple navigation
- 
RELIABLE AND DURABLE
 - IP67 rated for protection from dust and water ingress up to 1 meter for 30 minutes.
 - Compliant with MIL-STD-810-G for shock and vibration
- 
LONG-LIFE BATTERY
 - Powerful 4000mAh Lithium-Ion Polymer battery delivers up to 24 hours of operation
- 
CAR KIT
 - Dash-mount car kit available for safe in-vehicle calling
 - Features optional external speaker, palm microphone, visor microphone, and both wired and Bluetooth Push-to-Talk buttons
- 
LED FLASHLIGHT
 - Bright LED illumination at the touch of a button
- 
TEXT MESSAGING
 - Send, receive, and view text messages between dispatcher and other Hytera PoC devices
 - Also supports sending recorded audio messages
- 
SAFETY FEATURES
 - One-touch Emergency button enables emergency calls to dispatcher and sending alarms to other radios
 - Dispatcher can remotely stun (disable) or revive (return to service) if the radio is lost or stolen

Hytera Dispatch HyTalk

Dispatch



The PNC380S and other Hytera PoC devices are supported on a powerful web-based dispatch application.

Hytera HyTalk Dispatch supports instant group voice and video calling as well as individual calling. Dynamic groups can be quickly created with a simple list selection or geographically by selecting an area on the dispatch map. Hytera HyTalk Dispatch leverages the GPS built into the PNC380S for tracking of driver locations and travel routes with time stamps. The dispatcher may stun (turn off) and reactivate a radio, receive and transmit emergency calls and messages.

Target Applications

The PNC380S is designed for any organization that requires reliable group communications on the job or in remote vehicles.

- Schools and Universities
- Hospitals
- Warehouse and Logistics
- Security Companies
- Hotels and Resorts
- Property Management
- Plumbers and Electricians
- Construction and Building Materials
- Agriculture
- Manufacturing



Standard Accessories

INCLUDED WITH THE PNC380S



R003
Nylon Hand Strap



PS2023 and PC80
Power Adapter and MicroUSB Cable
Input: 100-240VAC, Output: 5VDC/2A



Bc50
Belt Clip



BP4006
4000mAh Li-Ion Polymer Battery

Optional Accessories



EHS24
C-Style 3.5mm Earpiece
with Mic and PTT button



POA121
PTT Ring and USB
charging cable (for use
with EHS24)



MCL35-S
Multi-Unit Charger
for Radios and Batteries

CK10 CAR KIT



WIRED ACCESSORIES FOR THE CK10 CAR KIT

The CK10 Car Kit is a rugged vehicle mounting assembly that enables the PNC380S to be installed on a vehicle dashboard and comply with DOT requirements. The Car Kit allows the PNC380S to be easily removed for handheld job-site communications. The Car Kit includes a locking bracket, an on/off power button, and ports for external speakers, microphones, and push-to-talk buttons. The CARKIT also functions as a docking charger for the PNC380S.

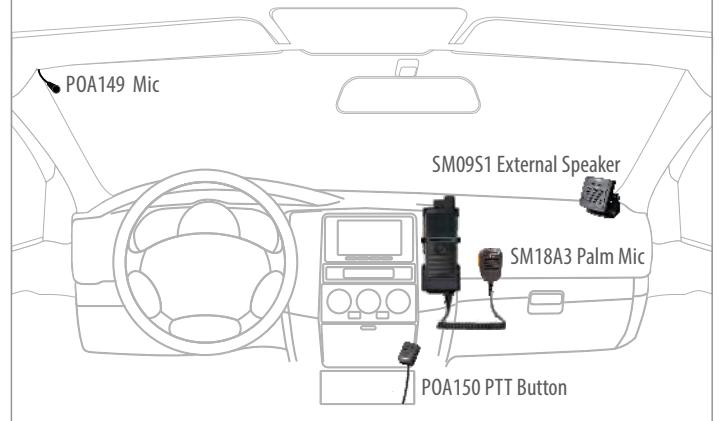

Specifications

Network Standards	
LTE	FDD:B2/B4/B5/B7/B12/B13/B25/B26
WCDMA	B1/B2/B4/B5/B8
GSM	850/1900 MHz
WLAN	2.4GHz and 5GHz, 802.11 b/g/n
Positioning System	GPS/A-GPS

General Specifications	
Dimensions (H x W x D)	5 27/32" x 2 3/8" x 1 1/8" (148 x 60 x 28mm)
Weight (with battery)	208g (with battery)
Memory	RAM: 1GB ROM: 8GB
	Extended: Micro SD/TF card, up to 32GB
SIM Card	Nano SIM 12.3mm x 8.8mm
Display	2.0" 320x240
	TFT/Non-touch
Ports	Micro USB 2.0
	3.5mm Audio Jack
	Dock Charger Interface
	Car Kit Connection Interface
Video and Images	Video: 480p @ 30fps for streaming, 720p @ 30fps for recording
	Images: 8MP
Operating Voltage	3.85V (Rated)
Battery	4000mAh (Li-ion)
Battery Life	≥24h (5-5-90 working cycle)

All specifications are subject to change without notice due to continuous development.

Transceiver	
Audio Power Output	1W (Rated) (Max: 2W)
Mic	Mic with Digital noise suppression

Environmental	
Dust and Water Proof	IP67 Standard
Shock & Vibration	MIL-STD-810 G Standard
Drop Resistance	1.2m
ESD	IEC 61000-4-2
	±8 kV (Contact) ±12 kV (Air)
Operation Temperature	-4°F to +140°F (-20°C to +60°C)
Storage Temperature	-22°F to +158°F (-30°C to +70°C)

Ordering Information

Part Number	Description
PNC3805	AT&T and T-Mobile approved PoC Device



Hytera Canada

Unit 11, 100 Leek Crescent, Richmond Hill,

ON L4B 3E6

905 305 7545

www.hytera.ca

info@hytera.ca



Hytera™ HyTalk and Hytera™ are registered trademarks of Hytera
© 2023 Hytera US Inc. All Rights Reserved.

PNC3805-DS-D 2/23